



THE BIGGEST,

SMALLEST FIREFIGHTER.

CEASEFIRE MINI_{PRO}

**AUTOMATIC MICRO-ENVIRONMENT
FIRE SUPPRESSION WITH MONITORING
CAPABILITY PROVISION**



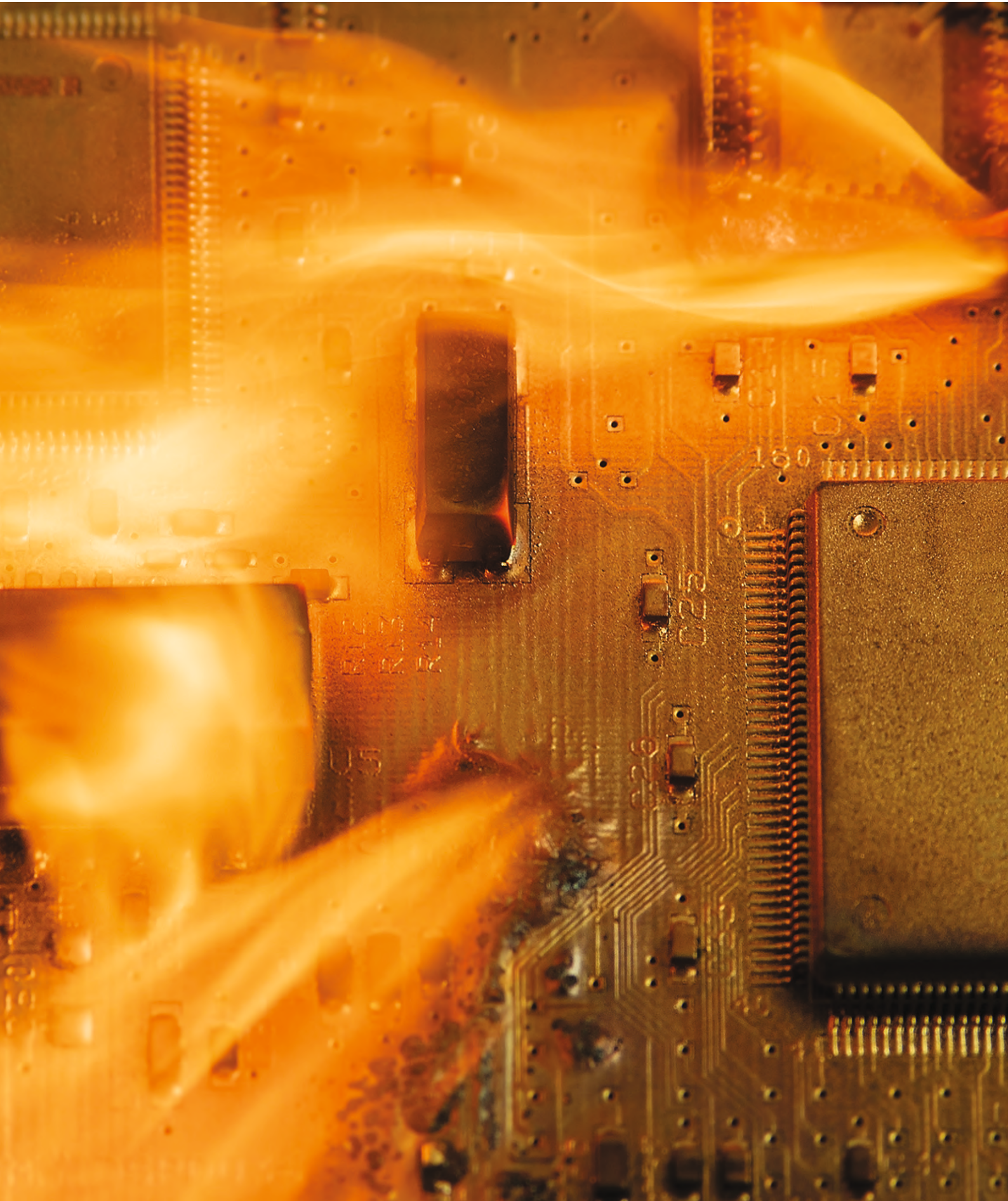



BEHIND EVERY FIRE ARE A FEW USUAL SUSPECTS.

Anyone who's ever been in a fire situation agrees: fire is the biggest foe. Mercilessly ruining everything in its path; be it expensive electronics, mementos or human life. But even the biggest of fires start small, and in an overwhelming majority of cases, experts can trace their origins to tiny enclosed areas, like an electrical cabinet with old wiring or a fuse box.

The only solution is to catch the fire in its nascent stage by guarding these enclosed

areas, so that it doesn't stand a chance of becoming big. Although advanced suppression systems that can detect and kill the fire exist in the market, they are not designed to protect microenvironments like electrical appliances, MCB (Miniature Circuit Breaker) panels or enclosed machinery.

What you need is an ultra-small suppression system that's unobtrusive and can take on a fire the moment it starts.

HELLO, MINI PRO

Introducing the Ceasefire Mini Pro, the biggest, smallest suppression system in town; and proof that some of the best things do come in small packages.

The Mini Pro is a state-of-the-art micro-environment suppression system that comes equipped with a provision to be made monitorable by pressure switch. The size of your palm, it sits snugly inside small enclosed spaces that are vulnerable to fire. When the temperature of the micro-environment exceeds a preset limit, the Mini Pro swings into action and automatically extinguishes the fire.

Place it inside your server. Pop it in the fuse box. The Mini fits anywhere, and protects everywhere!

EVOLVED TO TRULY PROTECT

Provision of a pressure port in the new improved Mini Pro makes it monitorable in nature by using a pressure switch. With this unique upgrade the user can integrate Mini with any third-party device such as a Fire Alarm System or a Standalone Sounder Beacon.



Tested by **bsi.**

Monitoring Capability

Presence of a pressure port in Mini allows it to be connected to a pressure switch. This makes Mini monitorable in nature, so the user can always check the unit's readiness and can be alerted on its activation by integrating Mini with any third-party device such as a Fire Alarm System, a Standalone Sounder Beacon or a Building Management System.



TYPES OF CEASEFIRE MINI_{PRO}

Ceasefire has designed a Mini to protect practically every kind of micro-environment, including those that cannot be reached by humans.



Mini Pro – Intuitive System

The Mini – Intuitive System is a direct suppression system which protects the micro-environment from inside. Place it inside or attach it to the inner wall of the micro-environment, and the Mini is ready to protect.



Mini – Adaptive System

The Mini – Adaptive System is a direct suppression system designed for those micro-environments which are too small to even accommodate a Mini, let alone other firefighting systems. In this case, the Mini container is installed outside, with its heat-sensitive glass bulb inside the micro-environment.

COMPONENTS OF THE MINI_{PRO}



Heat-sensitive Glass Bulb:

The Mini's heat-sensitive glass bulb acts as the heat detector. In case the temperature inside the micro-environment rises beyond a preset level, the glass bulb breaks to activate the system. In the Intuitive System, the glass bulb is attached to the main container. While in the Adaptive System, it is attached to a stainless steel barrel which extends from the container.

Ceasefire has specifically designed glass bulbs depending on the temperature conditions of the micro-environment to be protected.

■ In low-temperature settings, like air-conditioned offices, hospitals, server rooms, etc., 57°C is the ideal temperature for electrical cabinets.

QUARTZOID BULB KEY*

● 57°C / 135°F	● 68°C / 155°F	● 79°C / 174°F	● 93°C / 200°F	● 141°C / 286°F
----------------	----------------	----------------	----------------	-----------------

*Quartzoid bulb in alternate temperature settings as mentioned above are available on request and would be dependent on MOQ for your region. Please check the availability and delivery time before ordering.

**The pressure switch shown in the picture of Mini above is for representation purposes only. It is an optional device and is not a part of the standard products.



Stainless Steel Container:

The Mini's container is stainless steel that is corrosion resistant. Depending on the amount of extinguishing agent, there are five variants of the Mini container: 100g, 200g, 300g, 400g and 500g.

Stainless Steel Barrel:

The Adaptive System has an option of attaching a stainless steel barrel between the glass bulb and the container to extend the Mini deep into unreachable spots. When the glass bulb breaks, the extinguishing agent passes through the barrel and out of the broken glass bulb.

The barrel is available in three sizes: 50mm, 100mm and 200mm.



Pressure Gauge:

The Mini's state-of-the-art pressure gauge tells you that the extinguishing agent is under optimum pressure and the Mini is in top working condition.



Installation Mounts:

The Ceasefire Mini is attached to the wall of the micro-environment by means of mounts. These brackets make sure that Mini is not only securely mounted but also ensure no vibration.



UL Listed Pressure Switch (optional):

The provision of a pressure port makes the Mini Pro monitorable in nature by using a pressure switch so the user can always check the system's readiness. The role of pressure switch is to convert a mechanical action into a switching effect that completes the circuit to send a signal to activate the third party devices such as fire alarm systems, sounder beacons or building management systems.



FEATURES AND BENEFITS OF CEASEFIRE MINI_{PRO}



Ease of Use:

Being automatic, the Mini requires no prompt to start firefighting.



Fits Anywhere:

The Mini can easily fit into the spots that are most prone to fire.



Electronics-friendly:

The Mini is filled with clean agent Fluoroketone (FK) that cause no damage to your electronics.



Maintenance-free:

The Mini comes with 1 year warranty and the assurance of no leakage.



Easy to Install with 2 Mounts:

The Busbar mounts make installation a breeze.



Self-actuation:

Since the Mini is self-actuated, it spots the fire and protects even when no one is around.



No Power Supply Required:

The Mini uses a mechanical release mechanism to start firefighting.



A,B,C,

Works on All Classes of Fire:

The Mini can be used on any kind of fire, making it a truly versatile firefighter.



Actuating temperature:

Mini is programmed to activate at 57°C.



Protects all Microenvironments:

Available as an Intuitive or Adaptive System, the Mini protects everywhere.



Heat-sensitive Glass Bulb:

The Mini's glass bulb acts as a heat sensor that detects a rise in surrounding temperature.



Monitorable Option:

These automatic extinguishers can be connected with a pressure switch (optional) to become monitorable and integratable with third-party devices.



TECHNOLOGY MEETS DESIGN IN THE HANDY CEASEFIRE MINI^{PRO}

Built to protect micro-environments, the Ceasefire Mini automatically kicks into action in a fire situation.

INTUITIVE SYSTEM

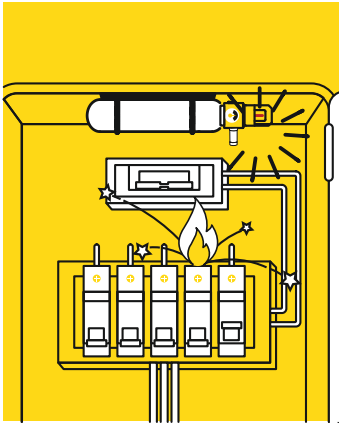

Stage 1:

A fire sparked by a short circuit causes the pressure inside the Mini's glass bulb to increase.

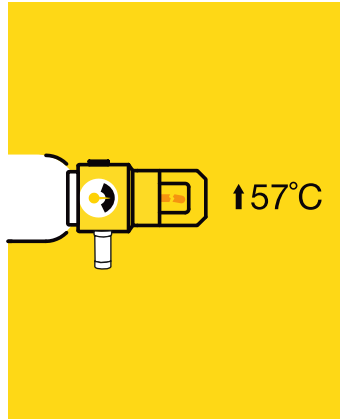

Stage 2:

The very second the temperature rises beyond a point, the bulb breaks and activates the system.

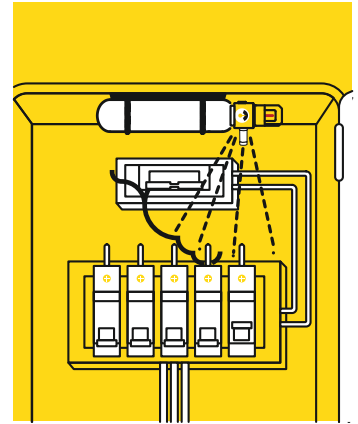

Stage 3:

Instantly, the extinguishing agent is dispersed, killing the fire in its early stages.

ADAPTIVE SYSTEM

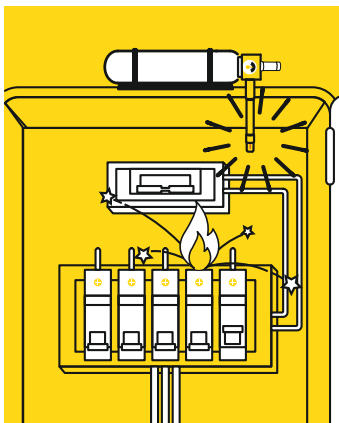

Stage 1:

A fire sparked by a short circuit causes the pressure inside the Mini's glass bulb to increase.

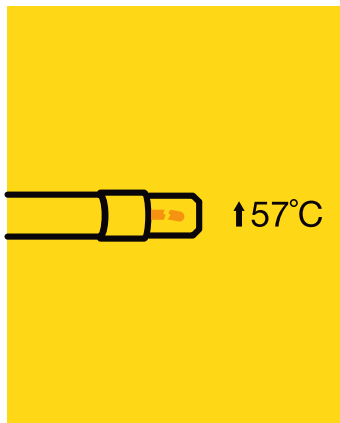

Stage 2:

The very second the temperature rises beyond a point, the bulb breaks and activates the system.

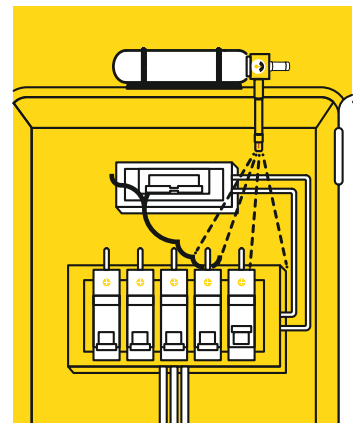

Stage 3:

Instantly, the extinguishing agent is dispersed, killing the fire in its early stages.



The green Ceasefire Mini is available in Fluoroketone (FK).

Fluoroketone is a clean agent and is not part of the F-Gas Regulations, therefore causes no collateral damage to your electronics or the Earth, making the Mini absolutely safe.



MINI SUPPRESSION SYSTEM. ZERO HASSLES.

Fitting the Mini is as easy as 1-2-3. It's the only suppression system in the market which can be installed without any help or technical support.

INSTALLING THE MINI PRO - INTUITIVE SYSTEM

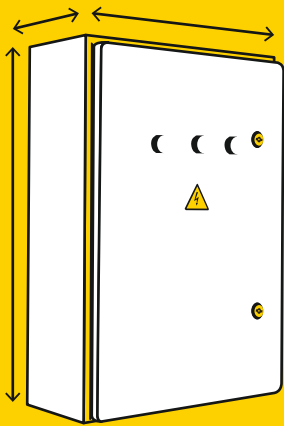

Step 1:
Measure the approximate volume of the enclosure you want to protect.

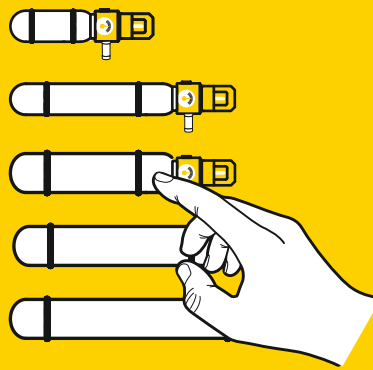

Step 2:
Choose the right variant of the Mini - Intuitive System.

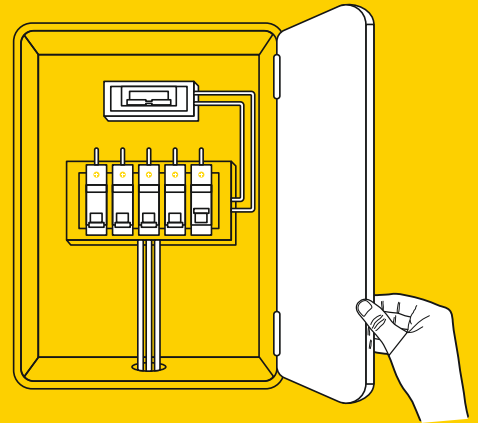

Step 3:
Open your electrical cabinet, AHU or machinery.

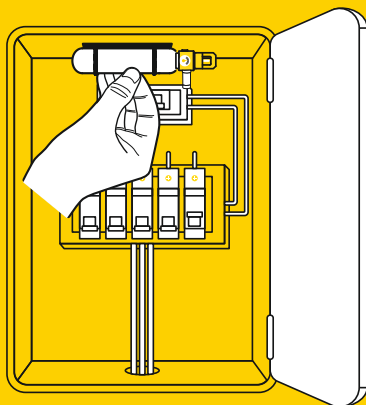

Step 4:
Place the Mini inside, vertically or horizontally. In case of large enclosures, you could screw its bracket to the wall inside and place the Mini on it.

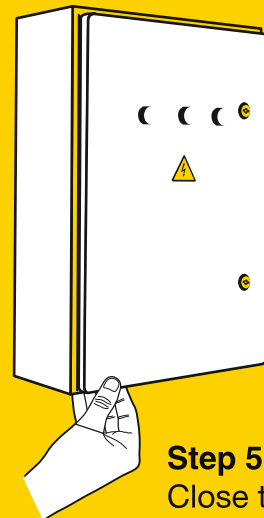

Step 5:
Close the enclosure.

INSTALLING THE MINI PRO - ADAPTIVE SYSTEM

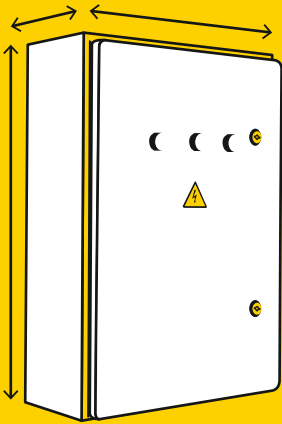

Step 1:
Measure the approximate volume of the enclosure you want to protect.

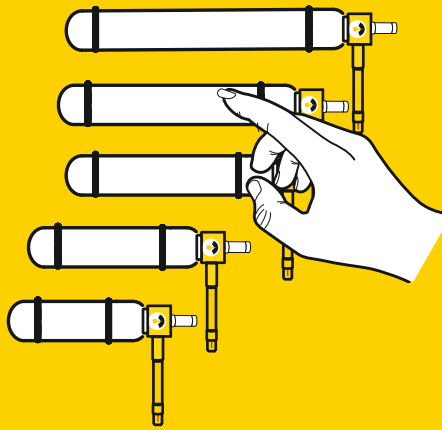

Step 2:
Choose the right variant of the Mini - Adaptive System.

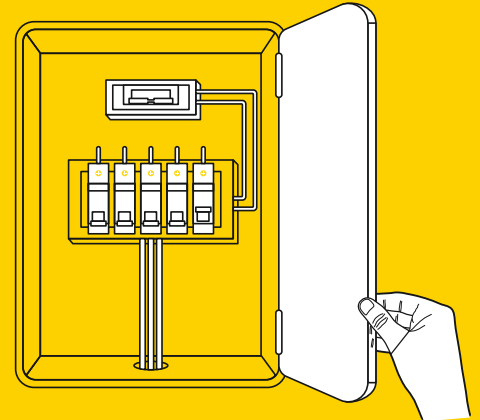

Step 3:
Drill a hole in the wall of your electrical cabinet.

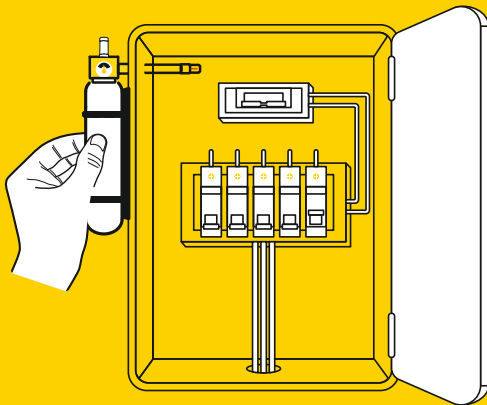

Step 4:
Place the Mini on the outside such that the barrel passes through the hole and the heat-sensing bulb is inside the cabinet.

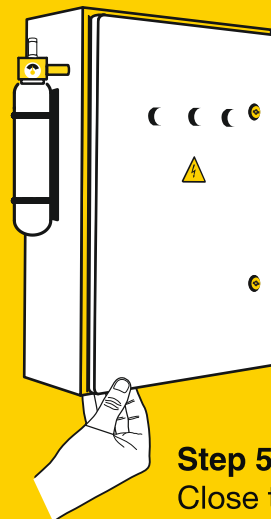

Step 5:
Close the enclosure.

THIRD PARTY INTEGRATION SCHEMES

Pressure switch in Mini Pro allows it to be monitorable by connecting Mini with third party devices such as Fire Alarm Systems, Stand alone Sounder Beacons or Building Management Systems. This integration makes Mini Pro a smart and fully versatile fire solution for your premises.

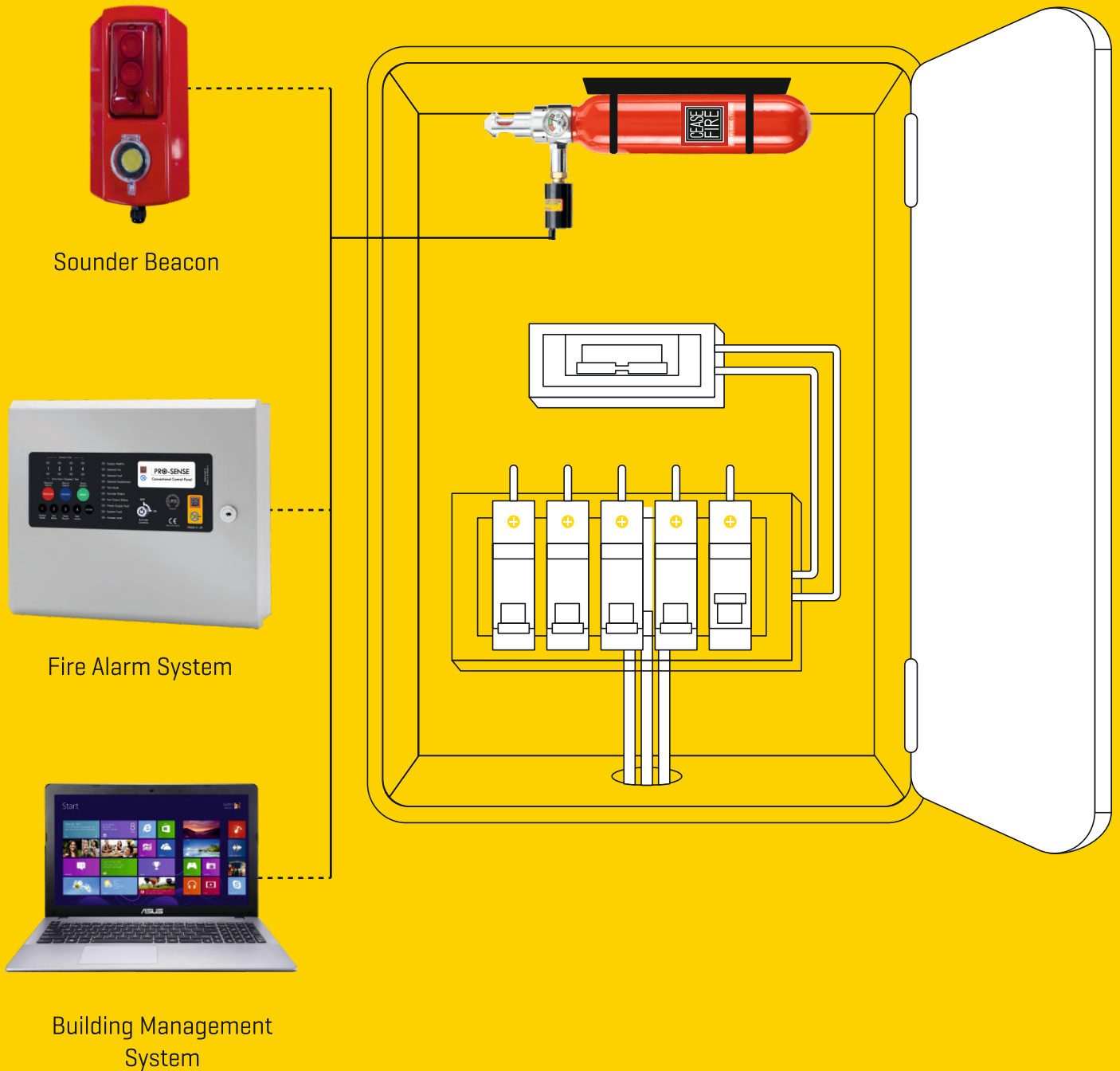

*The Above diagram is for representation purposes only.

APPLICATION AREAS

The Mini is built to protect electrical cabinets of all kinds in homes, offices, factories, schools and hospitals.



Offices and Data Centres:

With several workstations and computers, some running round-the-clock, offices and data centres are at a high risk of fire. A Mini sitting unobtrusively inside the office's busy electrical cabinet can detect a fire and extinguish it before it destroys your workplace and data. Besides, being powered by clean agent gas, it doesn't cause any discomfort and lets your staff continue working.



Homes:

Electrical cabinets and MCBs (Miniature Circuit Breakers) are blind spots in most houses, as the only time you look at them is when there is no power or when a switch trips. The Mini is built precisely for such an environment. Place it inside the cabinet and forget about it. Whether it's a short circuit or overheating, the Mini will take care of it.



Factories:

Old wiring. Irregular maintenance. A huge consumption of electricity. Electrical cabinets in factories are hotspots of fire, literally. Our tech team will help you determine how many Minis are required to protect the electrical cabinet in your factory so you can stop a fire before it ruins your business.



Schools:

Schools also consume a humungous amount of power, making their electrical cabinets high risk areas. Add to that the responsibility of managing thousands of students and suddenly, it has all the

makings of a major mishap. This is why auto detection of fires is important. And nothing does it better than Minis placed in the electrical cabinets.



Hospitals:

At any point of time, hundreds of patients undergo treatment in a hospital. There are complex scanning machines and labs to test these patients. Put together, all this leads to large power consumption. Minis cut the panic involved in a fire situation by automatically killing fires in the hospital's electrical cabinets.

WHICH MINI PRO VARIANT SHOULD YOU CHOOSE?

If there is a micro-environment in need of protection, you can be sure there is a Mini for it. Depending on the volume of the space you're protecting, Ceasefire has designed 5 variants of the Mini. Here's how you can find the one most suited to your requirements.

MINI 100 Gms*



Weight: **100 Gms**
Concentration: **9.5**
Volume in M³: **0.130**

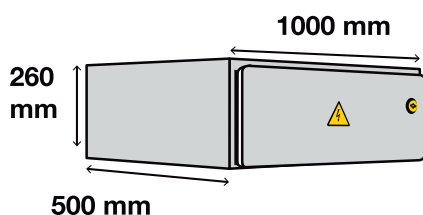

Suitable for sizes with volume ≤ 0.130 M³

Sample Size	Height in mm	Width in mm	Depth in mm
Type 1	260	1000	500
Type 2	380	420	75
Type 3	380	450	75
Type 4	380	495	75
Type 5	380	740	75

MINI 200 Gms**



Weight: **200 Gms**
Concentration: **9.5**
Volume in M³: **0.260**

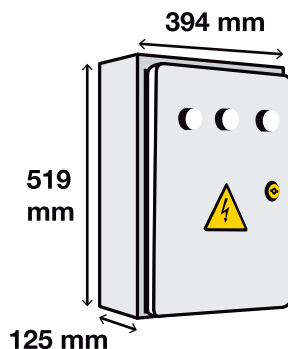

Suitable for sizes with volume ≤ 0.260 M³

Sample Size	Height in mm	Width in mm	Depth in mm
Type 1	520	1000	500
Type 2	519	394	125
Type 3	519	430	125
Type 4	519	466	125
Type 5	519	538	125

MINI 300 Gms*



Weight: **300 Gms**
Concentration: **9.5**
Volume in M³: **0.390**

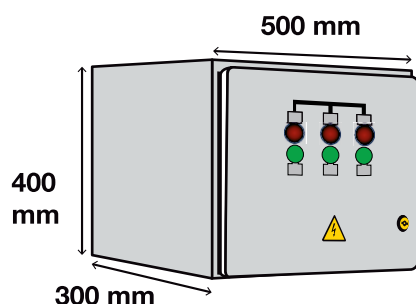

Suitable for sizes with volume ≤ 0.390 M³

Sample Size	Height in mm	Width in mm	Depth in mm
Type 1	780	1000	500
Type 2	400	500	300
Type 3	450	500	300
Type 4	500	500	300
Type 5	550	500	300

MINI 400 Gms**



Weight: **400 Gms**
 Concentration: **9.5**
 Volume in M³: **0.520**



Suitable for sizes with volume ≤ 0.520 M³

Sample Size	Height in mm	Width in mm	Depth in mm
Type 1	380	495	75
Type 2	519	466	125
Type 3	500	500	300
Type 4	700	500	300
Type 5	1250	500	300

MINI 500 Gms*



Weight: **500 Gms**
 Concentration: **9.5**
 Volume in M³: **0.650**

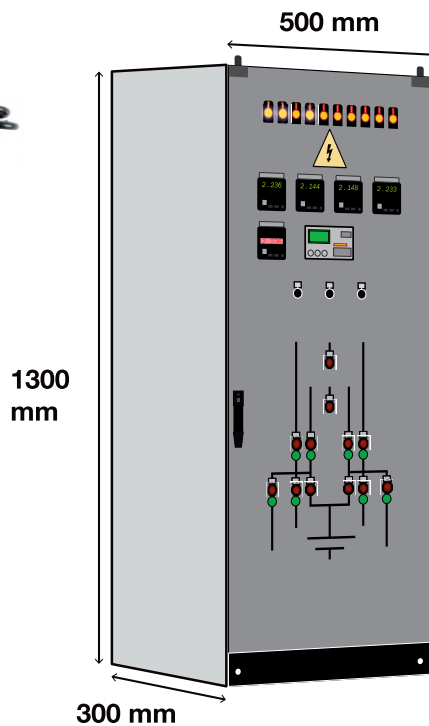

Suitable for sizes with volume ≤ 0.650 M³

Sample Size	Height in mm	Width in mm	Depth in mm
Type 1	1560	1000	500
Type 2	1000	500	300
Type 3	1200	500	300
Type 4	1250	500	300
Type 5	1300	500	300

*Readily available in stock.

**Available on order.

Scan the QR code to know more about the product



SOUNDER BEACON (OPTIONAL)

Unwavering Vigilance, Seamless Integration

The optional Sounder Beacon for Mini Pro is a smart upgrade that is thoughtfully designed to convert Mini Pro into a completely independent fire solution. Built for swift emergency response, this sophisticated

device combines a bright strobe light with a powerful audible alarm, providing clear and unmistakable alerts, every time Mini Pro is activated in a fire scenario, ensuring your micro-environments are always safeguarded.



Technical Specifications:

- 9V PP3 Battery powdered.
- 110DB Standalone combined Sounder Beacon, Red LED.
- 1x Input for Normally Closed Pressure Switch (open contacts while installed on product).
- External Push To Test (PTT) Momantary Switch Button.
- Security Cover over PTT Switch.
- Standby time 24 Months.
- Constant Run time 48 Hours.
- Red ABS Plastic Body Construction.
- IP55 Water Ingress Rated.
- Weight 750g.
- Length 290mm.
- Width 165mm.
- Depth 110mm.
- Battery Included.

Ceasefire Industries Private Limited

B1/ H1, 2nd Floor, Mohan Cooperative
Industrial Estate, Mathura Rd, New Delhi - 110044

Tel: **011-4184 6800**



Scan the QR code
to visit our website

Website : www.ceasefireworld.com

Follow us on:



Please check the product specifications at the time of placing your order. Specifications can change without notice due to our continuous R&D and product improvisation initiatives.